

INTERNAL DOOR

Sliding Door

RELIANCE HOME

SLIDING DOOR COLLECTION

Sliding Door



SL804



SL813



SL820



SL805



SL801



SL805



SL803



SL801



SL808



SL818



SL818 + 1/3 Louvres



SL801 + 1/3 Louvres

SLIDING DOOR TECHNICAL DRAWING

3D Visual

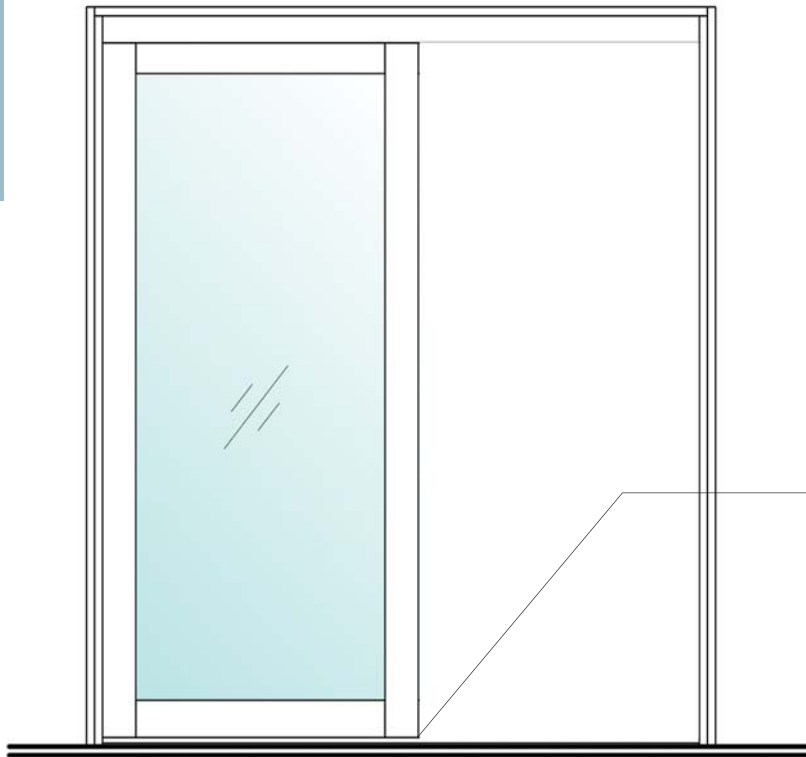

SECTIONAL VIEW BOTTOM FIXER

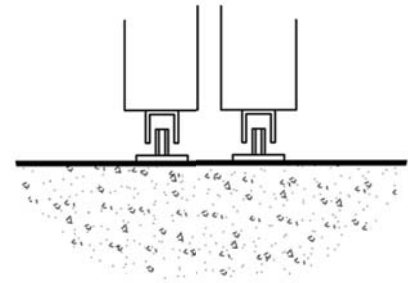

No Bottom Track
Suspended by 8 industrial nylon heavy duty roller

Application

2 track
2 leaves

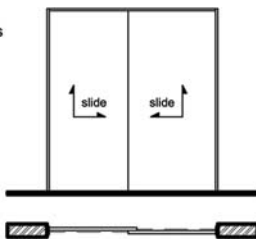

2 track
3 leaves with
central fixed light

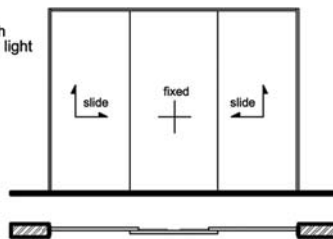

3 track

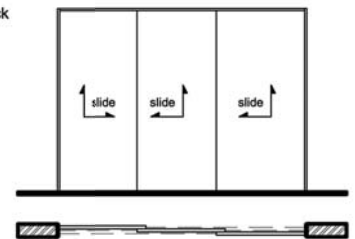

2 track
2 leaves with
side fixed light

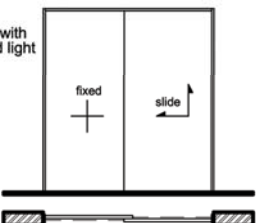

2 track
3 leaves

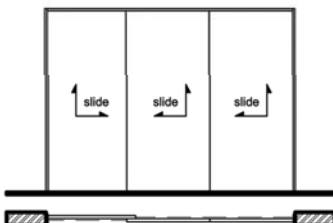

3 track
3 leaves with
side fixed light

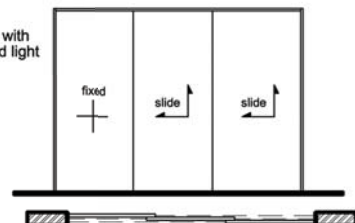

3D Visual

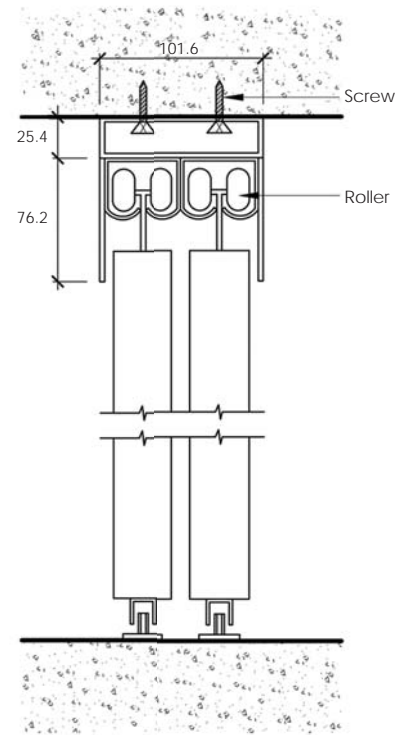
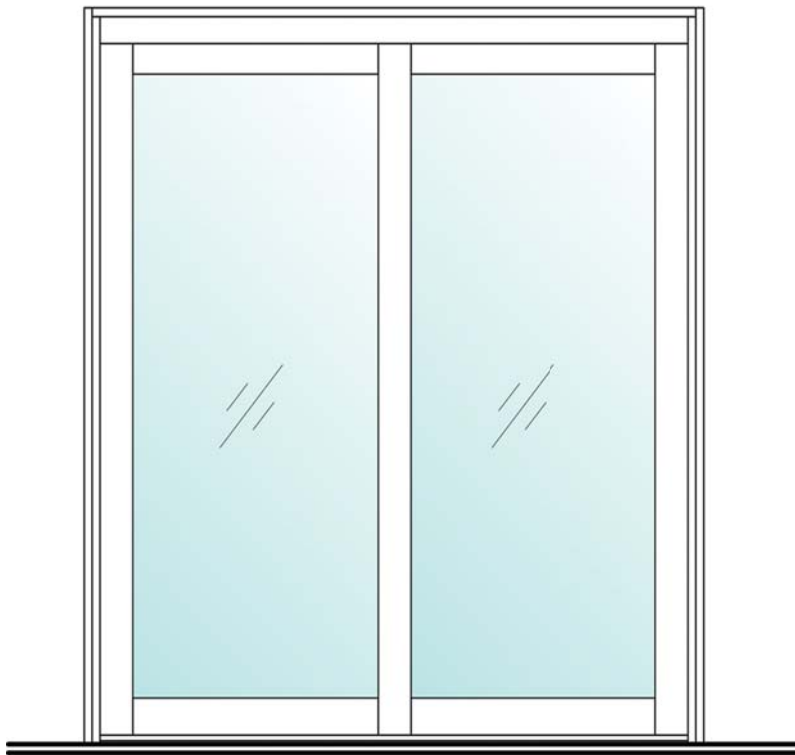

SIDE SECTIONAL VIEW

Top sectional detail

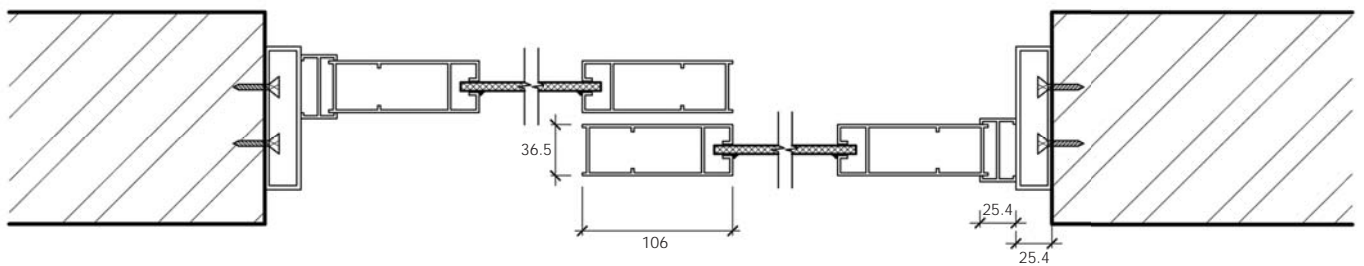

TOP VIEW

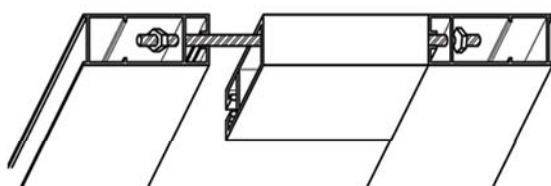

SECTIONAL FRAME VIEW
SUS304 Stainless Steel Screw

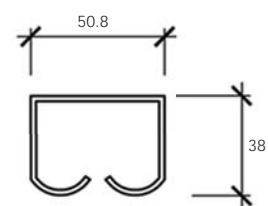

SECTIONAL TOP TRACK VIEW
Aluminum Profile

SLIDING DOOR MODEL



SW820



SW823



SW803



SW843



SW822



SW807



SW804

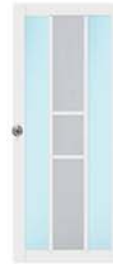

SW823



SW831



SW824



SW802



SW825



SW826



SW827



SW828



SW812



SW808



SW824

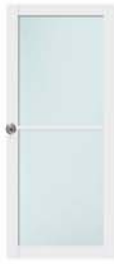

SW830



SW813



SW815



SW831



SW814



SW832



SW831



SW829



SW853



SW816



SW817



SW806



SW833



SW805



SW837



SW811



SW861



SW810



SW4055



SW4058



SW4049



SW1539



SW8129



SW818



SW829



SW819



SW820



SW821 Full Louvers



SW820 1/4 Louvers



SW868

Sleek
Simple
Space Saving

SLIDING DOOR FACT SHEETS



High Quality Powder Coat (OUTDOOR)

Thicker and better weather resistance Frame coating system



Embedded Handle Lock

Thicker and better wear tear resistance locking system



SL803



Industrial Nylon Roller (Heavy Duty)

Our rollers are made of finest quality nylon with multi labyrinth to provide an effective sealing support.

Maximum Panel Size:
4' x 8' H
(1220mm x 2438mm H)

Maximum Weight:
80kg



Trackless Door

Our sliding door is suspended by 8 heavy duty industrial nylon rollers.

Without bottom track, door is free from any coordination gliding problem between top and bottom rack.



Quality Aluminum Extrusion

Our sliding door uses highest quality surface finishes. We only use primary aluminum billets, also ensuring constant mechanical properties.

Various of Infil Panel Choices

1 Laminated Glass

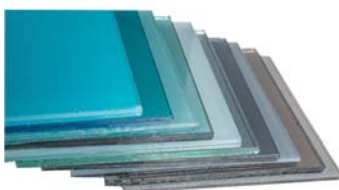

2 Acrylic Panel



www.reliancehome.com/catalog

3 Ecopanel Graphic



Sliding Door

ACRYLIC PANEL



Type of Infil Panel

"RP##" Translucent Effect

RP88 Pink	RP66 Grey	RP55 Brown	RP22 Blue	RP11 White

"SP##" Non-Translucent Effect

SP88 Milky Pink	SP83 Light Grey	SP85 Brown	SP87 Green	SP81 White

SP82 Sky Blue	SP84 Light Beige	SP80 Clear	

ECO ART PANEL



Green Technology VOC-FREE

Introducing "Eco-Solvent" ink, which is a VOC FREE and environmentally friendly materials for green printing.

More than **1,000** designs to choose here!



www.reliancehome.com/catalog

Sleek Simple Space Saving

LAMINATED GLASS

Non-Shattered Safety Glass



- ✓ Filter more than 99% of UV rays, Controlling visible light radiation & reducing heat build-up & thermal stress
- ✓ Reduce the transmission of unwanted sound into building environment and highway
- ✓ 50% of worldwide architectural & safety security glazing using Saflex



AW OB BB DG AW CG CB CBr CC



CUSTOMER PHOTO GALLERY



SL801



SL801



SL813



SL4055



SL1000



SL818



SL804



SL810



SL806