

INTERNAL DOOR

Bifold Door

RELIANCE HOME

BIFOLD DOOR COLLECTION



FD117 + 1/4 Louves



FD117 (SFN11324)



FD116



FD115



FD118



FD115



FD115



FD112



FD111



FD115 (SFN10904)



FD117 (SFN10214)



FD117 (SFN11322)



FD117 (SFN11324)



FD116



FD117

BIFOLD DOOR FACT SHEETS

NEW!
2 x better!



Stainless Steel Bearing Roller

- 100% Rust Proof Material
- Heavy Duty Bearing System
- Strong Aluminum Profile to Sustain the Glide System
- Smooth & Silent Roller System

High Quality Powder Coat (INDOOR)



Thicker and better weather resistance Frame coating system

Quality Handle Lockset



Quality Aluminum Extrusion



Bi - 4 Handle

Bi - 2 Handle



FD115

Various of Infil Panel Choices

1 Laminated Glass

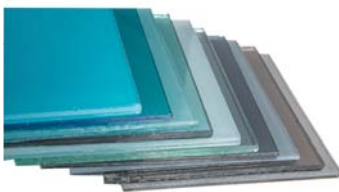

2 Acrylic Panel



www.reliancehome.com/catalog

3 Ecopanel Graphic



3D Visual

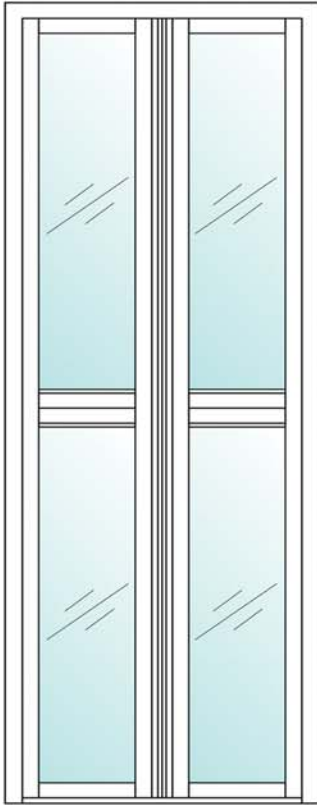

OUTER FRAME

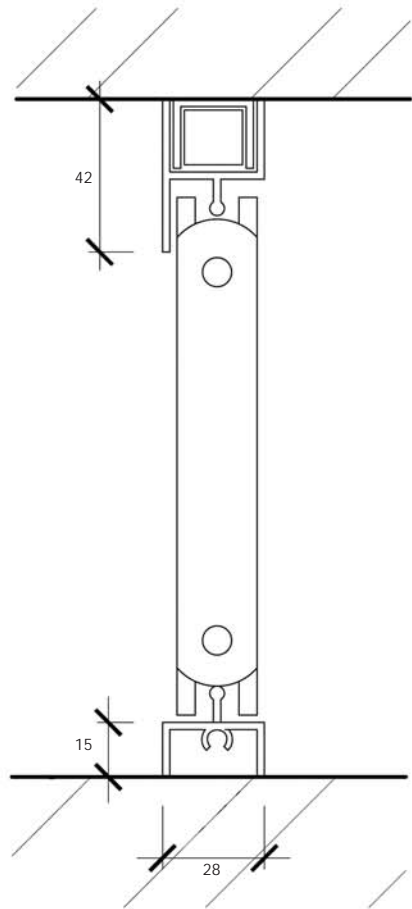

SIDE SECTIONAL

INSTALLATION MANUAL

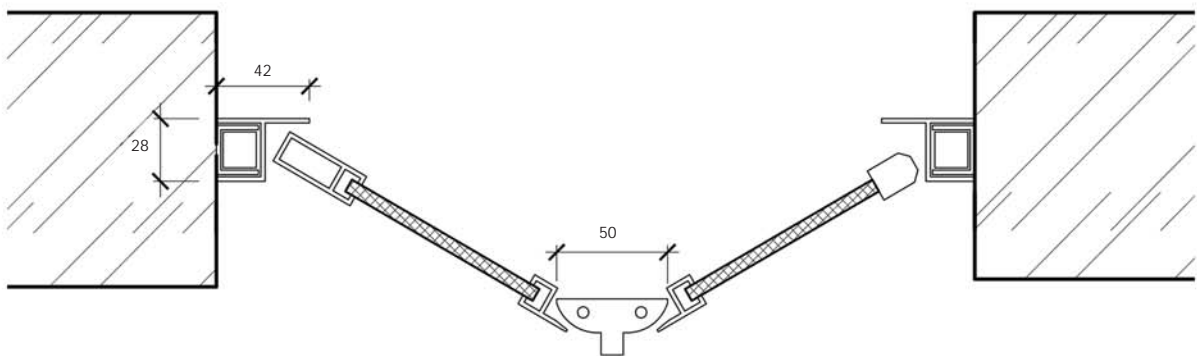

Door Mechanism

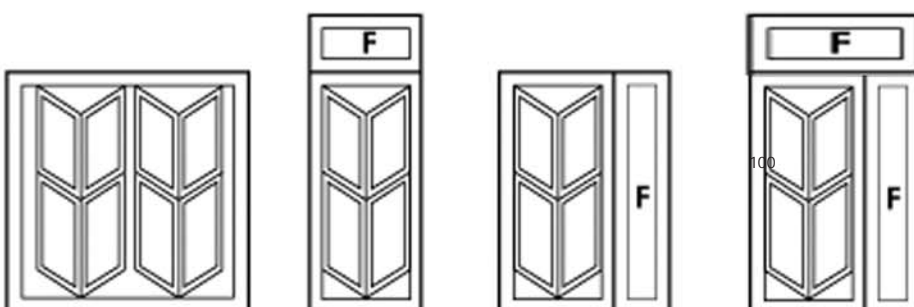

BIFOLD DOOR MODEL

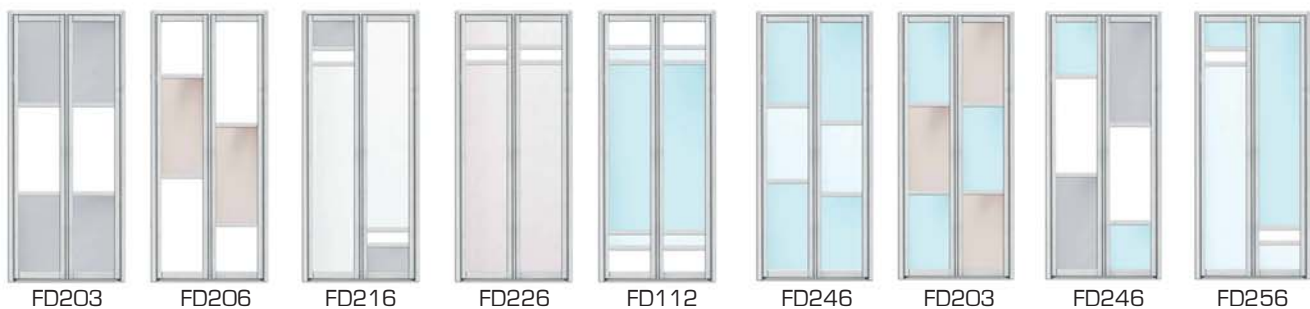
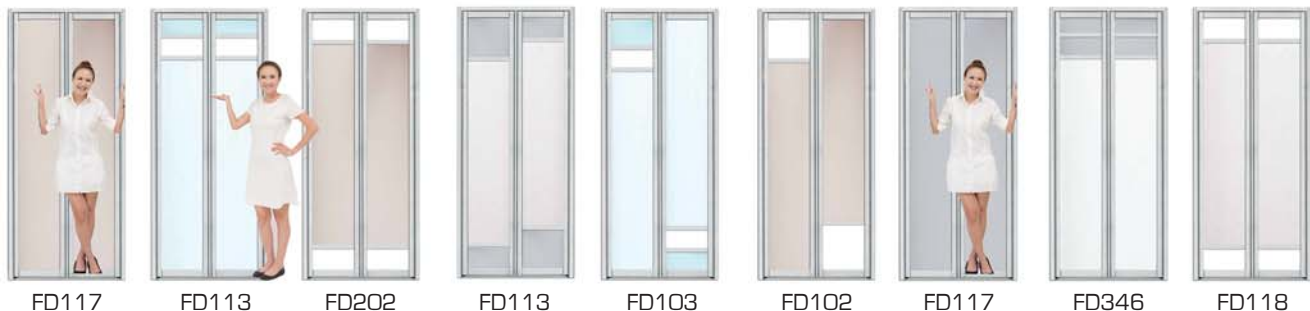

Sleek
Simple
Space Saving

BIFOLD DOOR HANDLE TYPE



FD116



FD115

Bi - 4 Handle



FD117



FD118

Bi - 2 Handle



- Built in handle is integrated with the door frame system.
- High Sustainability and Durability
- Sleek and modern design for convenience of the usage.

ACRYLIC PANEL



FD116



FD115

Type of Infil Panel



LAMINATED GLASS



FD117



FD118

Type of Infil Panel



- ✓ Filter more than 99% of UV rays, Controlling visible light radiation & reducing heat build-up & thermal stress
- ✓ Reduce the transmission of unwanted sound into building environment and highway
- ✓ 50% of worldwide architectural & safety security glazing using **Saflex** 

ECO ART PANEL

Green Technology **VOC-FREE**

Introducing "Eco-Solvent" ink, which is a VOC FREE and environmentally friendly materials for green printing.



FD116 (SFN12307)



FD115 (SFN11324)



FD117 (SFN10829)

More than **1,000** designs to choose here!



www.reliancehome.com/catalog



Sleek Simple Space Saving