

REH200

180° Pivot Door

REH200 Series



REHSR

Stainless Steel Round Header



Quality Door Hinge tested by:-



PSB Singapore
50,000 Cycles
Endurance Test

Grade A Tempered Glass Certified by:-



ANSI Z97.1-2004



Cert No:
BMP555249



Cert No:
BMP552817



Product Specification

- Surface Finishes : Glossy Polish/Matt
- Material : Brass Chrome or SUS304 Stainless Steel
- Test : PSB Test Singapore Certified (50,000 Cycles)
- Function : Pivot Door (Inward/outward/bothway)
- Glass : 6mm to 10mm Thickness Tempered ASTM C 1048, ANSI 97.1, BS 6206,

REH200

135° Swing Door Shower





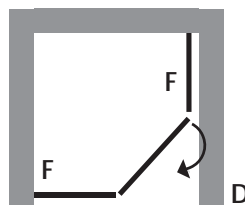

| Door Space Allocation |

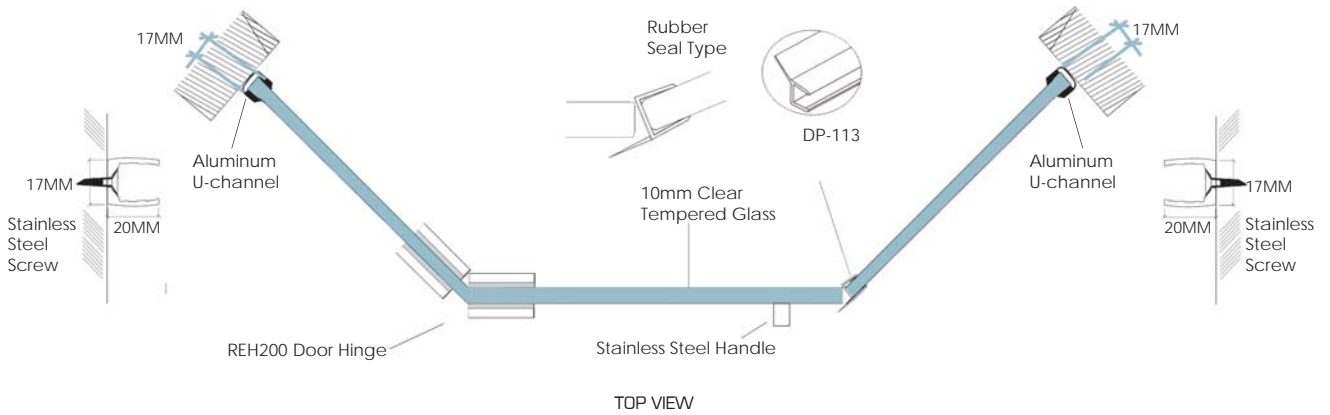
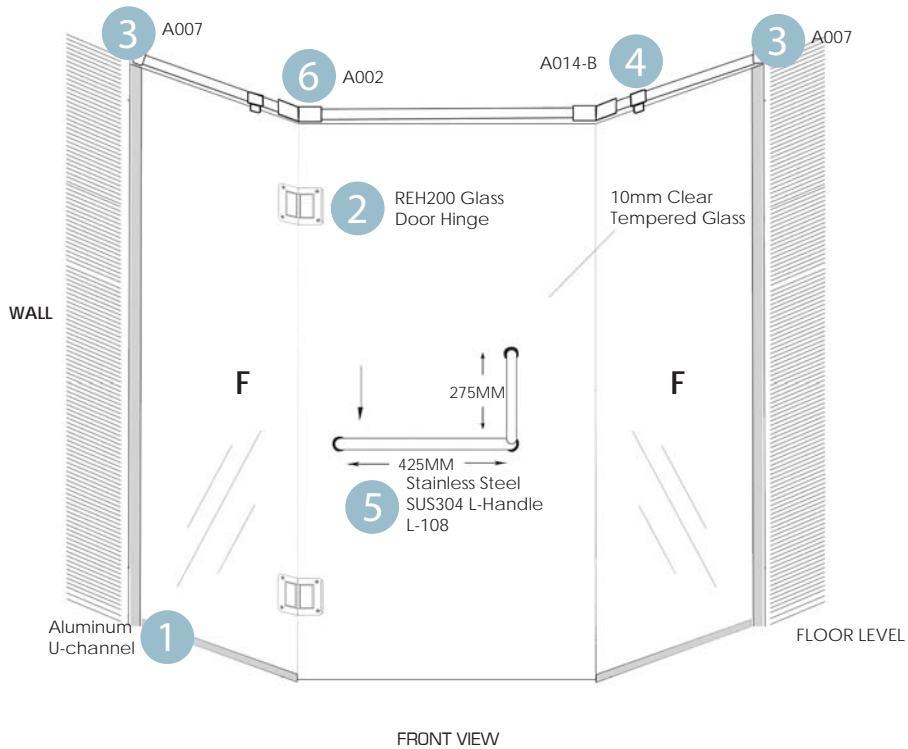

INSTALLATION MANUAL



Accessories List:-

- | | | |
|--|---|--|
| 
1 Aluminum U-Channel
Glossy Polished | 
2 REH200 Hinge
Brass Chromed | 
3 A007 - Header Clip
SUS304 Stainless Steel |
| 
4 A014B Stainless Steel Bar Holder
SUS304 Stainless Steel | 
5 L-108 Handle
SUS304 Stainless Steel
Size: 275mm x 425mm | 
6 A002
SUS304 Stainless Steel
135° Angle |

CUSTOMER PHOTO GALLERY

