

MultiFolding Door

RELIANCE HOME

MultiFolding Door







Product Specification

Frame Material	: Powder Coated Aluminum
Glass	: 6.38mm - 8.38mm Double Layer Laminated Glass
Function	: Folding Type (Inward/outward)

| Material Specification |



3D Visual

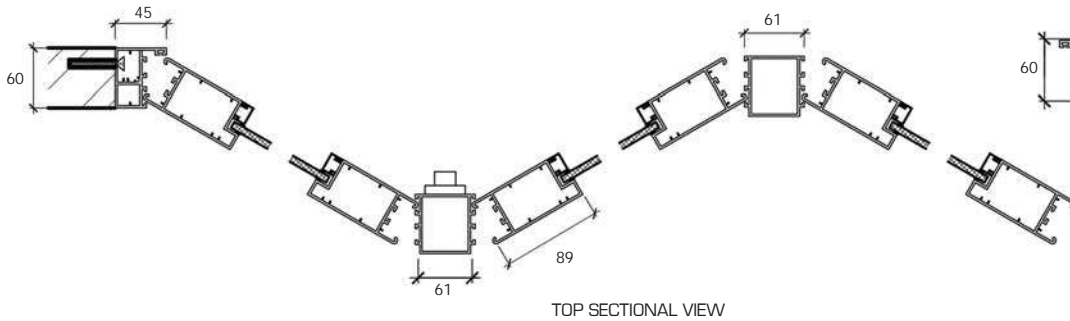
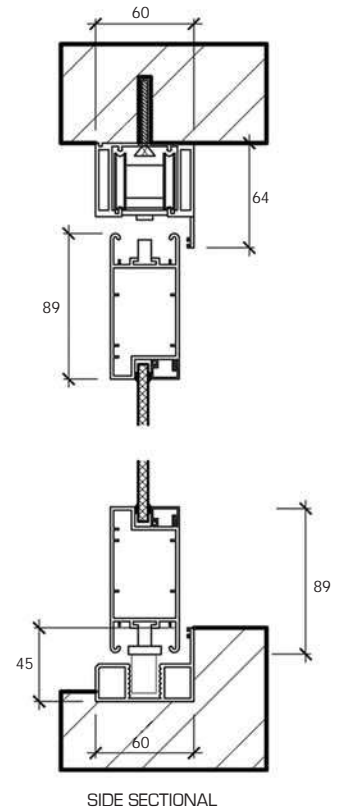
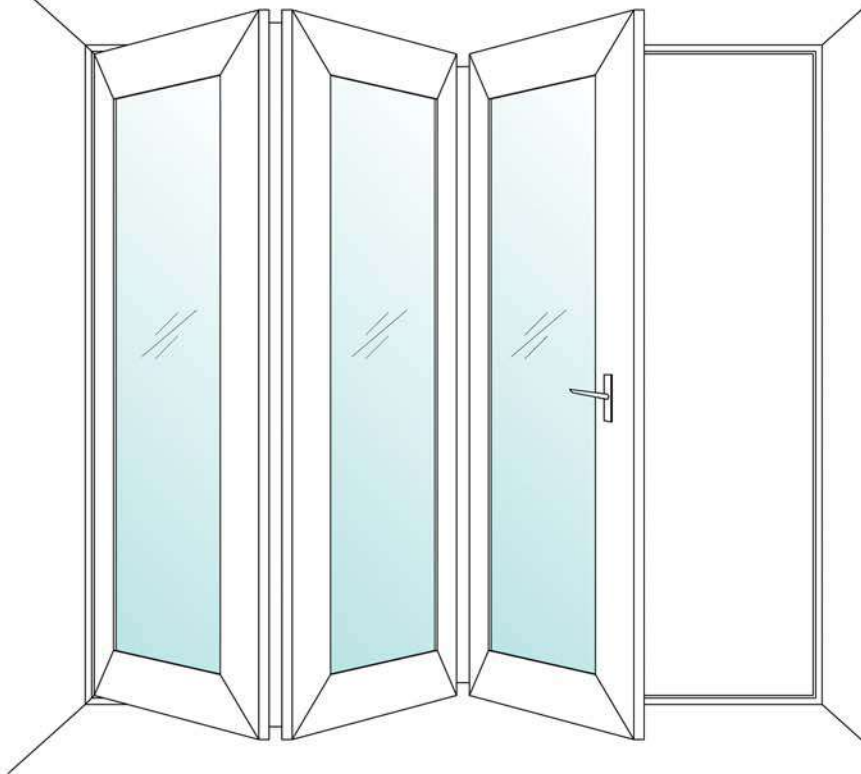

INSTALLATION MANUAL

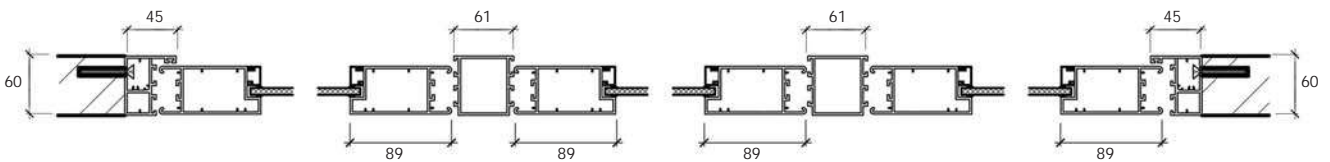

OUTER FRAME SECTIONAL



| MULTIFOLD DOOR Accessories |

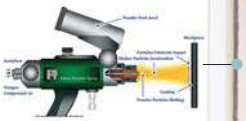

High Quality Powder Coat
OUTDOOR
 Thicker and better weather resistance Frame coating system



Highgraded ABS Lock Handle



Thicker & Heavier Alum Frame Profile



High-Performance

1. In the bottom part of the door, a carriage mounted on needle bearings slides in the threshold section.
2. The guiding threshold section is designed for diamntling-free cleaning and maintenance.
3. In the top part of the door, a hinge fitted with guiding rollers slides in the rail section.



MultiPoint Locking System
 - Better Security
 - Better weather sealing performance
 - Help reduce door warpage



Folding Butterfly Hinge (Heavy Duty)
 - Bolted Folding Hinge prevent loosen screw'



Highgraded ABS Lock Handle



Double Layer Nonshattered Safety Glass (PVB:USA)
 ANSI Z97.1 CPSC 16 CFR 1201 – Cat I

SOLAR -Screens out 99% of harmful & damaging UV rays up to 380nm(=SPF50+) Protects delicate plants, fabrics, carpets, furniture

SECURITY- Security Standards include:
 ASTM F1233/UL 972 (forced entry), ASTM F 1915 (forced exit), UL 752 (bullet resistant).

SOUND- Typical STC (Sound Transmission Class) ratings between 34 to 40* Can reduce perceived noise by minimum 50%



| Door Opening Mechanism |

3+0, 3+1, 5+0, 3+3, 7+0, 3+5, 5+5, 2+3, 5+1

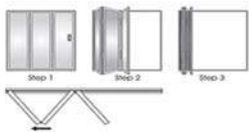

3 Door Series
No. of Panel
3 + 0

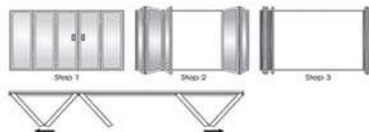

5 Door Series
No. of Panel
3 + 2

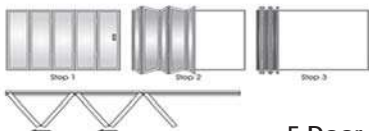

5 Door Series
No. of Panel
5 + 0

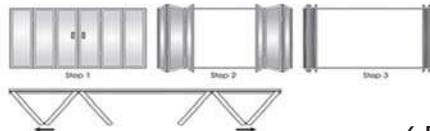

6 Door Series
No. of Panel
3 + 3

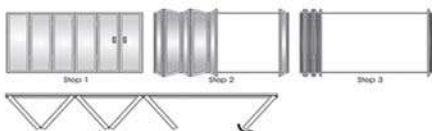

6 Door Series
No. of Panel
5 + 1



MANUAL CARE

Never use an abrasive cleaner on the hardware. Many of the components are coated with a clear lacquer that will be irreparably damaged if subjected to harsh, abrasive chemicals. It's advisable that drying the hardware with a clean, soft towel on a daily basis is the best way to maintain the hardware. If mineral deposits build-up, mix a couple of drops of a mild liquid soap into a cup of warm water. Using a soft, non-abrasive cloth, clean the hardware. Rinse thoroughly with clean, warm water and dry.



Product Specification

- Frame Material : Powder Coated Aluminum
- Class : 6.38mm - 8.38mm
 - Double Layer
 - Laminated Glass
- Function : Folding Type
 - (Inward/outward)

The Luxe Series

| Material Specification |



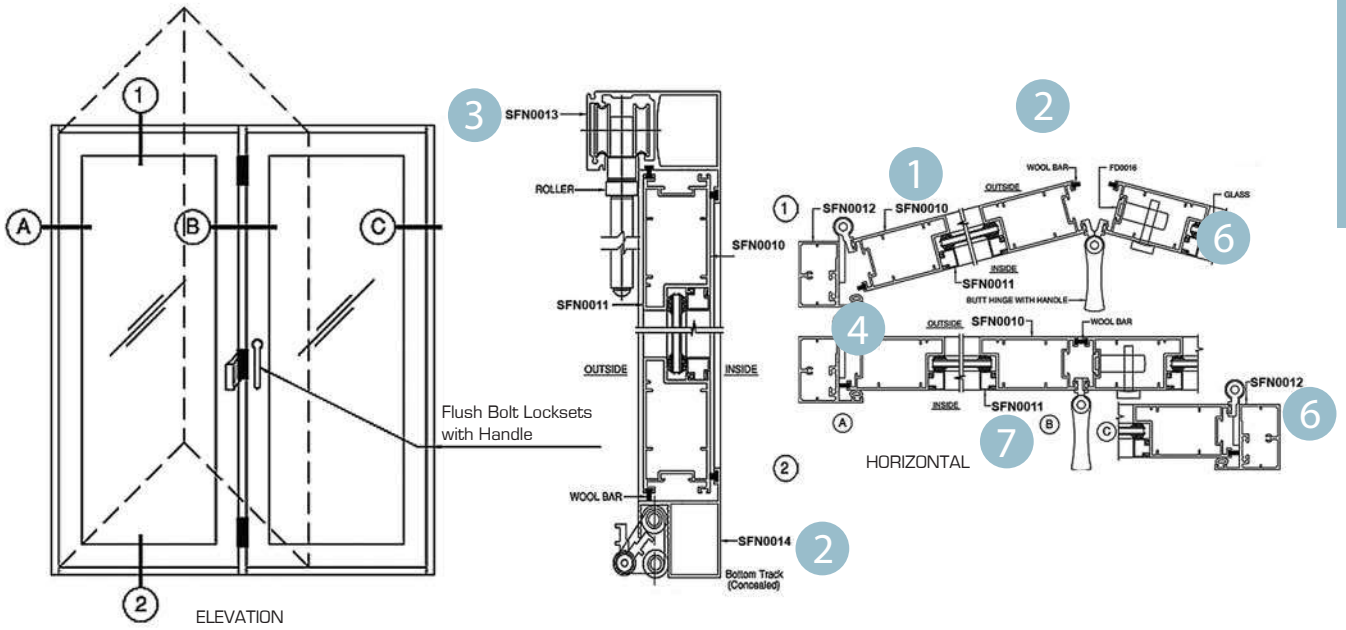

ALUMINIUM EXTRUSION PROFILE

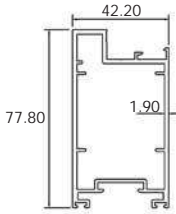
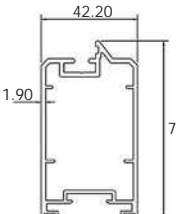
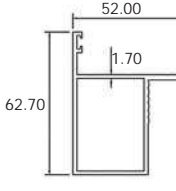
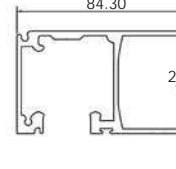
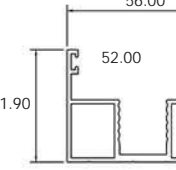
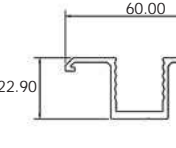
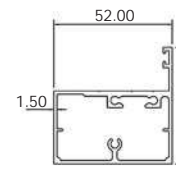
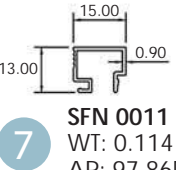
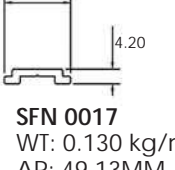
 <p>1 SFN 0010 WT: 1.342 kg/m (H) AP: 328.43MM</p>	 <p>2 SFN 0015 WT: 1.353 kg/m (H) AP: 325.32MM</p>
 <p>2 SFN 0014 WT: 1.007 kg/m (H) AP: 283.01MM</p>	 <p>3 SFN 0013 WT: 2.021 kg/m (H) AP: 473.23MM</p>
 <p>4 SFN 0018 WT: 0.897 kg/m (H) AP: 251.29MM</p>	 <p>5 SFN 0017 WT: 0.565 kg/m (H) AP: 218.87MM</p>
 <p>6 SFN 0012 WT: 1.037 kg/m (H) AP: 221.49MM</p>	 <p>7 SFN 0011 WT: 0.114 kg/m (H) AP: 97.86MM</p>  <p>8 SFN 0017 WT: 0.130 kg/m (H) AP: 49.13MM</p>

MULTIFOLDING DOOR

3D Visual

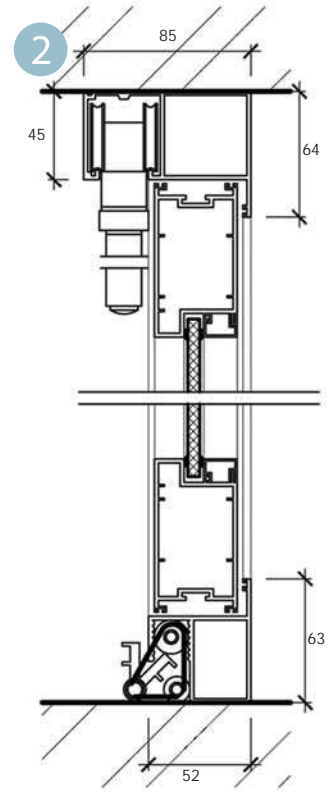
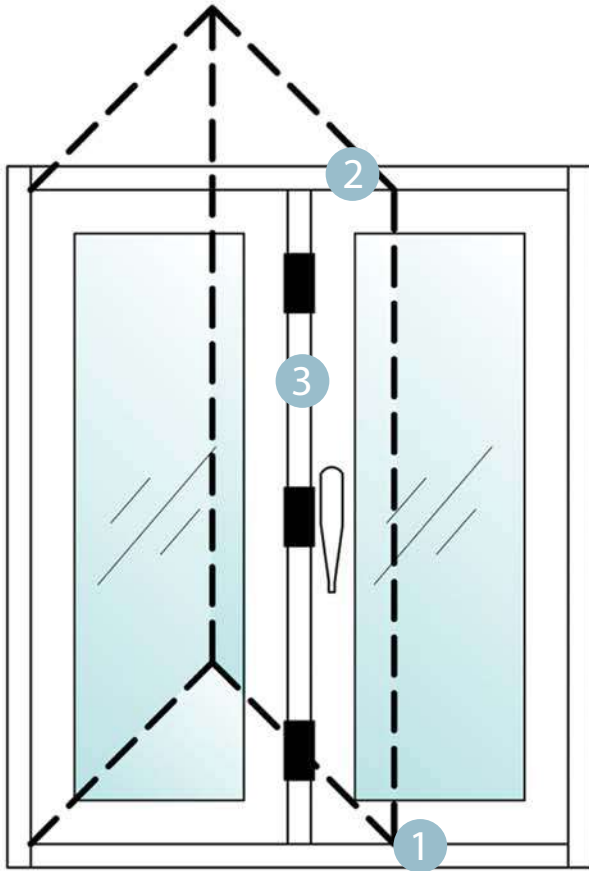

SIDE SECTIONAL

DOOR OPENING DRAWING

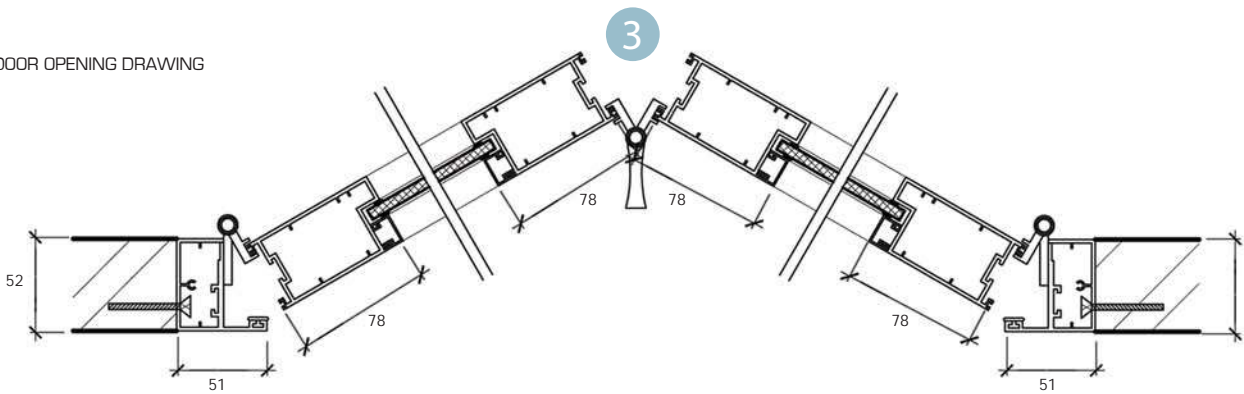

DOOR CLOSING DRAWING

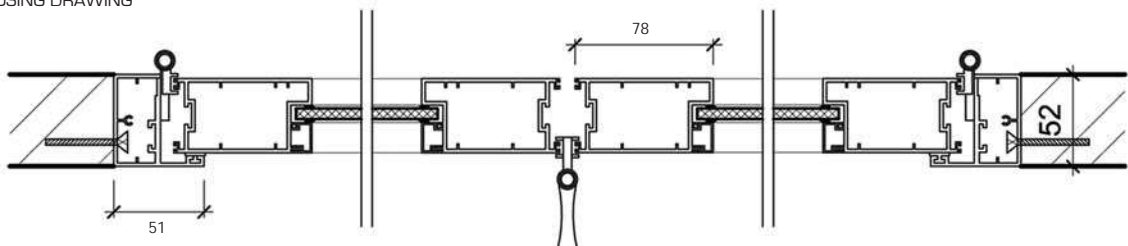

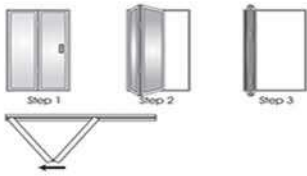

2 Door Series
No. Of Panel
2 + 0

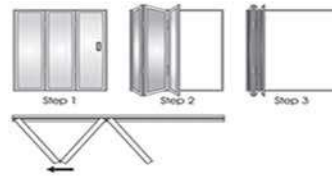

3 Door Series
No. Of Panel
3 + 0



3 Door Series
No. Of Panel
2 + 1

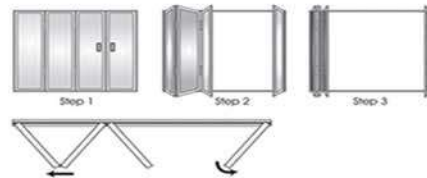

4 Door Series
No. Of Panel
3 + 1

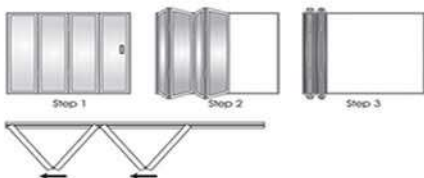

4 Door Series
No. Of Panel
4 + 0

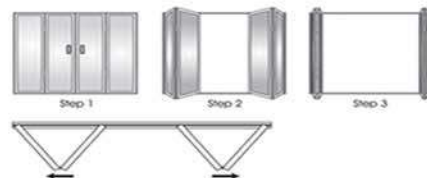

4 Door Series
No. Of Panel
2 + 2

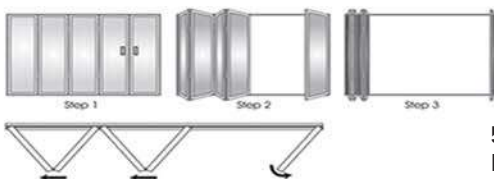

5 Door Series
No. Of Panel
4 + 1

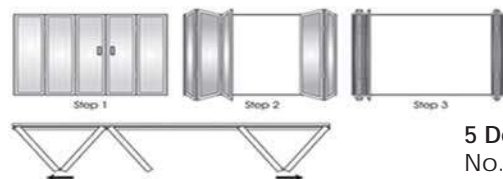

5 Door Series
No. Of Panel
3 + 2

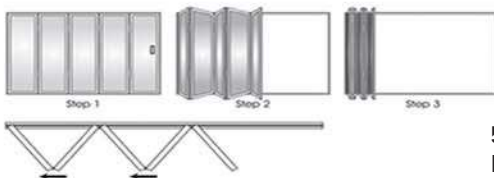

5 Door Series
No. Of Panel
5 + 0

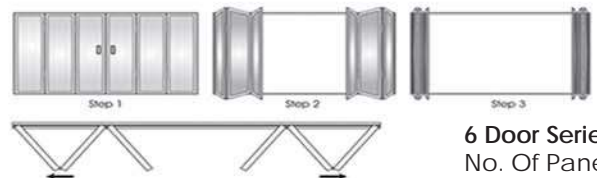

6 Door Series
No. Of Panel
3 + 3

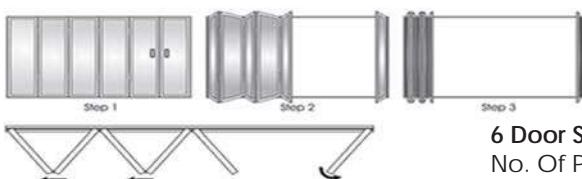

6 Door Series
No. Of Panel
5 + 1

Sliding ⇄ Swing ↶

OUTER FRAME DRAWING

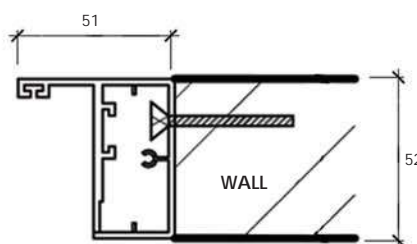
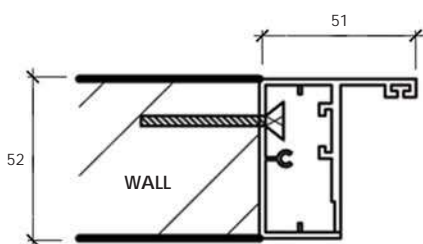

| MULTIFOLD DOOR Accessories |



High Quality Powder Coat
OUTDOOR
 Thicker and better weather resistance Frame coating system



Highgraded ABS Lock Handle



Thicker & Heavier Alum Frame Profile



High-Performance

1. In the bottom part of the door, a carriage mounted on needle bearings slides in the threshold section.
2. The guiding threshold section is designed for dismantling-free cleaning and maintenance.
3. In the top part of the door, a hinge fitted with guiding rollers slides in the rail section.



MultiPoint Locking System

- Better Security
- Better weather sealing performance
- Help reduce door warpage



Folding Butterfly Hinge (Heavy Duty)

- Bolted Folding Hinge prevent loosen screw'



Slat & Lock



Double Layer Nonshattered Safety Glass (PVB:USA)
 ANSI Z97.1 CPSC 16 CFR 1201 – Cat I

SOLAR -Screens out 99% of harmful & damaging UV rays up to 380nm(=SPF50+) Protects delicate plants, fabrics, carpets, furniture

SECURITY- Security Standards include:
 ASTM F1233/UL 972 (forced entry), ASTM F 1915 (forced exit), UL 752 (bullet resistant).

SOUND- Typical STC (Sound Transmission Class) ratings between 34 to 40* Can reduce perceived noise by minimum 50%



Open up 90% Space
Gives you the luxury
of unblock view

