



RELIANCE HOME,  
ALWAYS MAKE YOU FEEL CONTENTED



# Contents

|                                    |       |
|------------------------------------|-------|
| ■ Company Overview                 | 1-2   |
| ■ Project Reference                | 3-4   |
| ■ A Complete Customer Satisfaction | 5     |
| ■ Warranty                         | 6     |
| ■ Aluminium Door Series            |       |
| • Bitfold Door                     | 9-12  |
| • Swing Door                       | 13-14 |
| • Sliding Door                     | 15-18 |
| • Multifolding Door                | 19-20 |
| • Pd Door                          | 21-22 |
| • 12mm Hanging Glass Door          | 23-24 |
| ■ Aluminium Window                 |       |
| • A Series Casement Window         | 25-28 |
| ■ Shower Screen Series             |       |
| <i>Full Framed Shower Series</i>   |       |
| • RS Series                        | 31-40 |
| <i>Frameless Shower Series</i>     |       |
| • RB Series                        | 41-46 |
| • REH Series                       | 47-52 |
| • 50TB Series                      | 53-58 |
| • KK Series                        | 59-63 |
| • Accessories                      | 64-66 |
| ■ Kitchen Cabinet                  |       |
| • Basics                           | 69    |
| • Extravagant                      | 70    |
| • Spraypaint                       | 71-72 |
| • Classics                         | 73-74 |
| ■ Wardrobe System                  |       |
| • Antijump System                  | 75-76 |
| • The Walk In                      | 77-78 |
| • Decorative-Glass                 | 79-80 |
| • Material Choice                  | 81    |



Reliance Home provides every detail of your home construction process. Our goal is to provide a safe, hygienic home at the most affordable price.

With its diversity range of product from shower screen aluminium door, windows to a full collection of kitchen cabinets and other cabinetry work, Reliance committed herself to lead the lifestyle in this industry.



## COMPANY OVERVIEW



Reliance Metal is the leading force in Malaysia Shower Screen and Aluminium Door Industry. Founded in 2000, Reliance has grown to be a dominant brand within the premium bathroom sector and Aluminium Door sector.

Reliance were exclusively an aluminium door manufacturer when the company was founded, but their portfolio has grown, to now offer a complete range of shower door products, Aluminium Doors, Windows, Kitchen Cabinets and wardrobe, that offer first and foremost quality, balanced with unrivalled design, style and innovation. The current product offering comprises of distinct product collections:

- Shower Screen
- Aluminium Door
- Aluminium Window
- Tempered Glass Door
- Kitchen Cabinet
- Wardrobe

Reliance brand is a formidable force within the architecture industry; additionally consumer awareness is generated through securing consistency in Product Quality and Customer Service, certified by ISO 9001:2008 Quality Management System. Reliance Products come with two years warranty and after sales service.

Reliance Kitchen Sdn Bhd, one of the subsidiaries, produces Kitchen and wardrobe cabinets to provide more interior solution to our customers.

The company primarily focused is to develop a one stop solution centre for our customers with creative and innovative solutions provided by our company.

*leading innovative lifestyle*

Reliance Metal Industries Sdn Bhd All Rights Reserved.  
This publication is available on a single user license only. A single-user license allows clients to place purchased report on one (1) computer system and NOT make use of the report on a corporate computer network. No part of this publication may be reproduced, stored in a retrieval system or transmitted in any form or by any means, electronic, mechanical, photocopying, recording or otherwise, without the prior permission of the publisher, Reliance Metal Industries Sdn Bhd. The facts of this report are believed to be correct at the time of publication but cannot be guaranteed. Please note that the findings, conclusions and recommendations from Reliance Metal Industries Sdn Bhd are based on information gathered from public domain, interviews and secondary sources, where accuracy may not always be a guarantee. However, Reliance Metal Industries Sdn Bhd does not accept any liability whatsoever for actions taken based on any information that may subsequently prove to be incorrect.



We make moving home a lot easier





## PROJECT REFERENCE

RELIANCE has been actively involving in the projects of Malaysia. Be it Shower Screen, Aluminium doors or shower screen, Reliance has been known for its product quality and prompt delivery promises.

With the Quality Management of ISO9001:2008, Reliance ensures their project clients of its promises and requirements are up to their expectation.

## PROJECT PORTFOLIO

- 
**Ken Bangsar @ Bangsar**  
 Product: Frameless Shower Screen  
 An exclusive condominium development of modern living.



- 
**Amverton Park @ Bukit Kemuning**  
 Product: Frameless Shower Screen  
 48 units of Bungalows



- 
**Suria Stonor @ KLCC**  
 Product: Frameless Shower Screen  
 An exclusive condominium development of modern living.



- 
**Kuchai Avenue Condo @ Kuchai Lama**  
 Product: Framed Shower Screen  
 An exclusive condominium development of modern living.



- 
**Swiss Inn Hotel (KL)**  
 Product: Aluminium Sliding Door  
 An exclusive condominium development of modern living.



- 
**Tune Hotel**  
 (Downtown KL, Downtown Penang, Kuching Waterfront, Borneo)  
 Product: Folding Frameless Shower & Bathroom Door



## PROJECT PORTFOLIO

### Completed Projects

- 
**Paramount @ Kemuning Utama**  
 Product: Frameless Shower Screen



- 
**Lawsonia @ Setia Alam**  
 60 Units of Cluster House



- 
**Seputeh Point @ Taman Seputeh**  
 Type: Bungalows



- 
**Dynasty Garden Condo**  
 Product: Full Frame Shower  
 An exclusive condominium development of modern living.



- 
**Malaysian Airline Golden Lounge**  
 Product: Frameless Shower Screen  
 An exclusive condominium development of modern living.



- 
**The Residence @ TTDI**  
 Product: Aluminium Sliding Door  
 An exclusive condominium development of modern living.

- 
**Beverly Hill**  
 Product: Framing Shower Screen  
 40 Units of Bungalows



**A. Complete Customer Satisfaction**



**Call Center/ After Sales Services**

At Reliance, we have a one stop centre to assist every enquiries. All customer service personal are well versed in all aspects of the products to help better understand your queries and technical support. Call between 8:30am to 5:30pm Monday to Friday and 8:30am to 1pm on Saturday on 03-89623288 or email us at sales@reliancemetal.com.my



**Spare Part Facilities**

Original spare parts are available at all times for the complete range of Reliance Home products. Should you need any help of any defects, our technician will be able to change and repair the parts at the minimum waiting time.



**Delivery Facilities**

Ensuring you don't have to wait too long for your move-in schedule, our fleet of delivery will try best effort to ensure the products are delivered in the promised time frame. We have more than 10 trucks delivering goods up and down the country.



**Intensive Human Resource Training**

Reliance Home emphasizes on Human Resource training very seriously. All sales personnel, administration staff, production and installation teams must undergo intensive training to ensure their eligible capability of work. Performance



**Warranty**

Reliance have a reputation for quality and reliability, so whichever showering product from the Reliance Home will come with 2 years Warranty.

All thoughed glass conformal to EN12150-1:2000.

**Quality Management**

Reliance management system is backed by ISO9001:2008. Customer satisfaction is our ultimate goal. Due to continued product development, Reliance Home Sdn Bhd reserve the right to alter specifications without prior notice.



All images, illustrations and information contained within this brochure are the property of Reliance Metal Industries Sdn Bhd and cannot be reproduced without prior written consent. This applies to use in any form of medium, both written and electronic.

*leading innovative lifestyle*



## ALUMINIUM DOOR

- Bifold Door
- Swing Door
- Sliding Door  
(No bottom rail)
- Sliding Door  
(With Bottom rail)
- Multifolding Door
- Pd Door
- 12mm Hanging Glass Door





## Aluminium Folding Door



FD117



FD112



FD113



FD117/FIBERED



FD116



FD116



FD111



FD117+  
1/4 LOURVES



FD117+  
1/2 LOURVES



FULL LOURVES

### Bi-fold DOOR

Choose your door mechanism

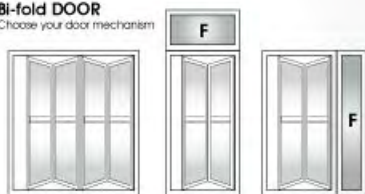

Add Aluminium Louvers to Your Door Deco  
Choose your fav Panel Design





### Solids Acrylic

**Reliance** offers wide range of Acrylic color to your favorite choice. The reasons for choosing fine acrylic over glass or wood are persuasive: clean lines, more impact resistant and insulates better than glass. Its glossy surfaces and design versatility combined with an exceptional clarity are just a few of the advantages.



Frame Model Choice:



### Acrylic Panels

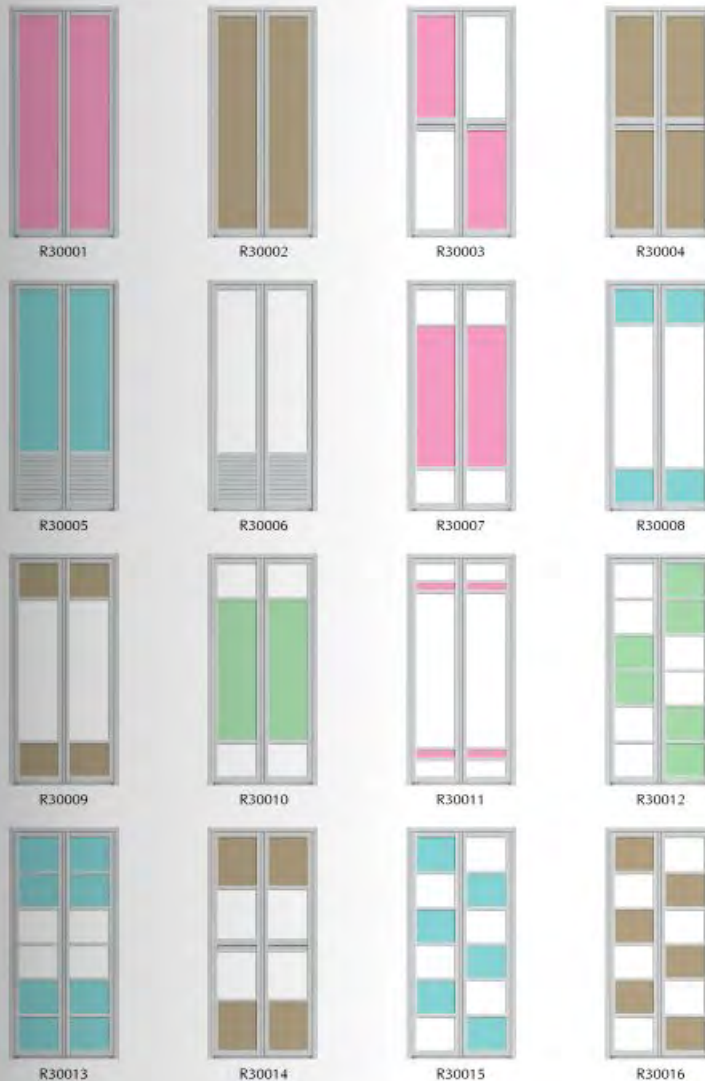





### Swing Door

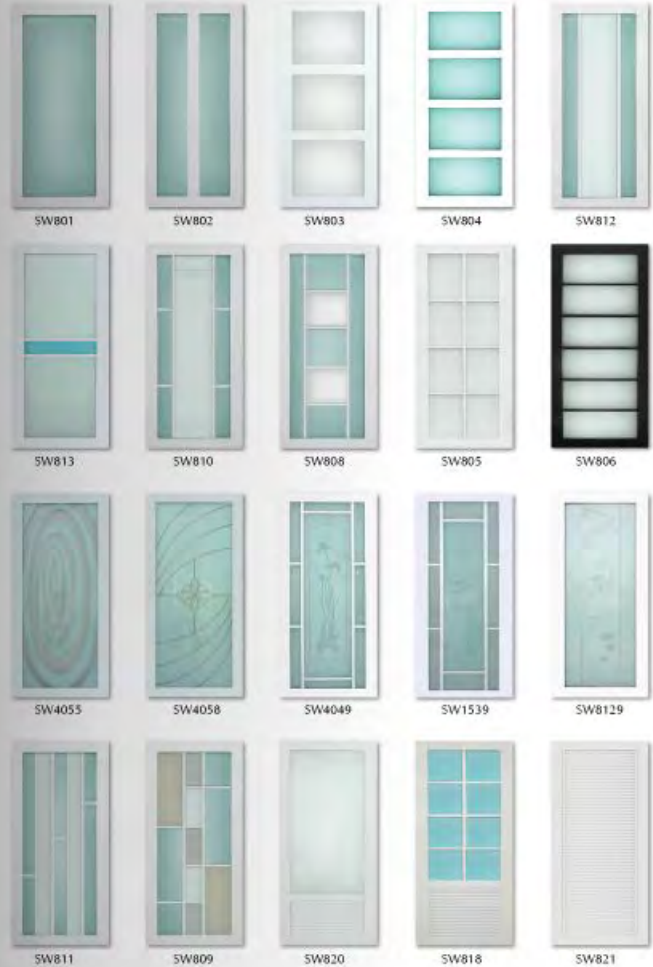



### Sliding Door



### Sliding Door



#### Door Mechanism

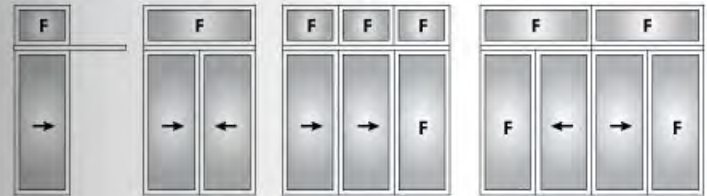

- High Quality Workmanship
- Customization Available
- Ensured Product Reliability
- 11 Years Experience
- Customer Service ensured

#### Lock Option:





# Sliding Door With Bottom Track

## Typical Assembly Details

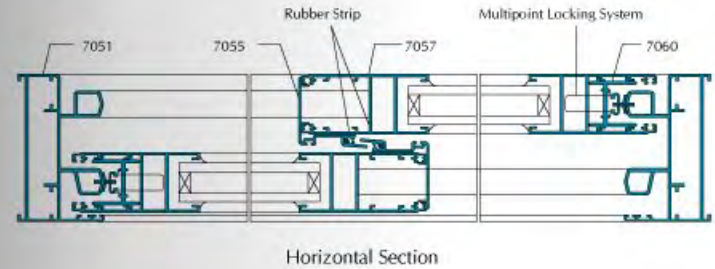
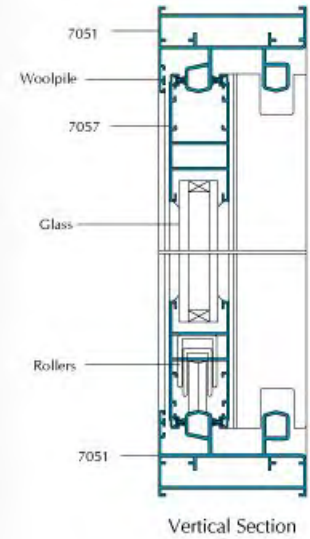
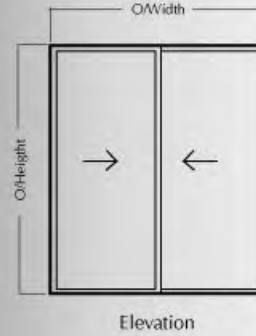





### Multifolding Door

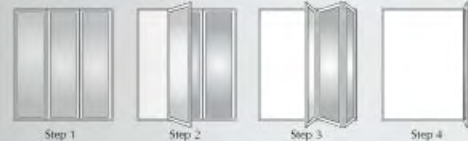

MULTIFOLDING DOOR

MULTIFOLDING DOOR

You deserve a bigger space





## Pd Door



## Pd DOOR



### Pd Door



### Panel Door

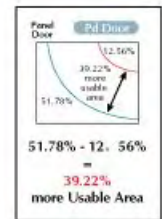

The smallest swing area of only 12.56% that of conventional swing door. Swing Capacity up to 180 Degree.



Users will benefit from a sizable amount of 39% additional usable space for other purposes.



Despite the complications of the system as it may seem, the operation is amazingly easy and user friendly. Slide and swing.



PSB tested to last an average 100,000 cycles which is equivalent to a life spend of 15 years.



Pd door offers clear door access as no unsightly bottom rail is required. With no barrier at the bottom, safety and accessibility is greatly enhanced.





12MM HANGING GLASS DOOR



RLH-3H



12MM HANGING GLASS DOOR

OPENING MECHANISM

1 Fixed Panel + 1 Door



2 Panel Sliding



**MODEL: RLH-3H**  
Framed Sliding Shower

|                |                                |
|----------------|--------------------------------|
| Specification  | 2-Panel Sliding                |
| Infill Panel   | 12mm Tempered Glass            |
| Frame Finish   | -                              |
| Door Opening   | Sliding One Way                |
| Extra Features | SUS 304 Stainless Steel Handle |





## ALUMINIUM DOOR





## A SERIES CASEMENT WINDOW

### TECHNICAL DRAWING

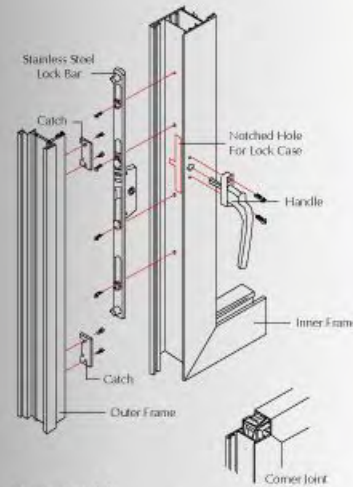

**Frame Material:**  
 Aluminium Thickness : 1.4MM  
 Aluminum Grade : 6063 - T5  
 Infil Panel : 6.38 - 6.76 Laminated Glass Panel\*  
 Lockset Material : SUS 304 Stainless Steel  
 Locking System : 2 point  
 Handle : Zinc Die Cast

Handle Choice:







## SHOWER SCREEN

- RS Series
- RB Series
- REH Series
- 5018 Series
- KK Series
- Pd Door
- Accessories





## RS SERIES

### Aluminium Full Frame

RS Series is a shower system designed in Aluminium framework. The sliding door panel are fully framed to achieve 100% water proofing. The aluminium frame comes with variety of color choices from Original Anodised to many other colors of Powder coating. The infill panel comes with different types such as Polystyrene, Fiberglass and tempered glass. RS series is full of freedom of design, no wonder everyone wants to have it.



## RS-120

### 2-Panel Sliding

RS Series



#### OPENING MECHANISM



#### MODEL: RS-120

Framed Sliding Shower



|                       |   |
|-----------------------|---|
| <b>Specification</b>  | 2-Panel Sliding                           |
| <b>Infill Panel</b>   | Polystyrene Panel                         |
| <b>Frame Finish</b>   | Anodised / Power Coated                   |
| <b>Door Opening</b>   | Sliding One Way / Both Way Sliding*       |
| <b>Extra Features</b> | Magnetic Closure Stripe, Premium S Handle |

RS-130  
3-Panel Sliding



**new** MODEL: RS-130  
Framed Sliding Shower



|                       |   |
|-----------------------|---|
| <b>Specification</b>  | 5-Panel Sliding                           |
| <b>Infill Panel</b>   | 4mm Thick 'S' Design Tempered Glass       |
| <b>Frame Finish</b>   | Anodised / Power Coated                   |
| <b>Door Opening</b>   | Sliding One Way / Both Way Sliding*       |
| <b>Extra Features</b> | Magnetic Closure Strips, Premium S Handle |



**new** MODEL: RS-130  
Framed Sliding Shower



|                       |   |
|-----------------------|---|
| <b>Specification</b>  | 3-Panel Sliding                           |
| <b>Infill Panel</b>   | 4mm Thick 'S' Design Tempered Glass       |
| <b>Frame Finish</b>   | Anodised / Power Coated                   |
| <b>Door Opening</b>   | Sliding One Way / Both Way Sliding*       |
| <b>Extra Features</b> | Magnetic Closure Strips, Premium S Handle |



**new** MODEL: RS-130  
Framed Sliding Shower



|                       |   |
|-----------------------|---|
| <b>Specification</b>  | 2-Panel Sliding                           |
| <b>Infill Panel</b>   | 4mm Thick 'S' Design Tempered Glass       |
| <b>Frame Finish</b>   | Anodised / Power Coated                   |
| <b>Door Opening</b>   | Sliding One Way / Both Way Sliding*       |
| <b>Extra Features</b> | Magnetic Closure Strips, Premium S Handle |





RS Series

**RS-140**  
3-Panel Sliding



RS Series

**RS-431**  
3-Panel Sliding + Fixed



OPENING MECHANISM



**new**

**MODEL: RS-140**  
Framed Sliding Shower



|                       |   |
|-----------------------|---|
| <b>Specification</b>  | 3-Panel Sliding                           |
| <b>Infill Panel</b>   | 4mm Thick Clear Tempered Glass            |
| <b>Frame Finish</b>   | Anodised / Power Coated                   |
| <b>Door Opening</b>   | Sliding One Way / Both Way Sliding*       |
| <b>Extra Features</b> | Magnetic Closure Stripe, Premium S Handle |

OPENING MECHANISM

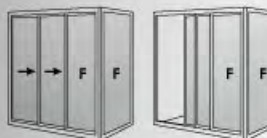

**new**

**MODEL: RS-431**  
Framed Sliding Shower



|                       |   |
|-----------------------|---|
| <b>Specification</b>  | 3-Panel Sliding + Fixed                   |
| <b>Infill Panel</b>   | Polystyrene Panel                         |
| <b>Frame Finish</b>   | Anodised / Power Coated                   |
| <b>Door Opening</b>   | Sliding One Way / Both Way Sliding*       |
| <b>Extra Features</b> | Magnetic Closure Stripe, Premium S Handle |



**new**

**MODEL: RS-220**  
Framed Sliding Shower



|                       |   |
|-----------------------|---|
| <b>Specification</b>  | 4-Panel Sliding                           |
| <b>Infill Panel</b>   | Polystyrene Panel                         |
| <b>Frame Finish</b>   | Anodised / Power Coated                   |
| <b>Door Opening</b>   | -   |
| <b>Extra Features</b> | Magnetic Closure Strips, Premium S Handle |

**MODEL: RS-220** 4mm Polystyrene



|                      |                         |
|----------------------|-------------------------|
| <b>Specification</b> | 4-Panel Sliding         |
| <b>Infill Panel</b>  | Polystyrene Panel       |
| <b>Frame Finish</b>  | Anodised / Power Coated |



**MODEL: RS-220** 4mm 'S' Design CTG



|                      |                         |
|----------------------|-------------------------|
| <b>Specification</b> | 4-Panel Sliding         |
| <b>Infill Panel</b>  | 4mm 'S' Design CTG      |
| <b>Frame Finish</b>  | Anodised / Power Coated |



**RS-220**  
4-Panel Sliding



**OPENING MECHANISM**



**RS-111**  
4-Panel Folding



**RS-109**  
3-Panel Folding



OPENING MECHANISM



**MODEL: RS-111**  
Framed Folding Shower



|                       |   |
|-----------------------|---|
| <b>Specification</b>  | 4-Panel Sliding                           |
| <b>Infill Panel</b>   | 4mm Thick Clear Tempered Glass            |
| <b>Frame Finish</b>   | Anodised / Power Coated                   |
| <b>Door Opening</b>   | Folding Type                              |
| <b>Extra Features</b> | Top/Down Closure Stripe, Premium S Handle |

OPENING MECHANISM



**MODEL: RS-109**  
Framed Folding Shower



|                       |   |
|-----------------------|---|
| <b>Specification</b>  | 3-Panel Folding                           |
| <b>Infill Panel</b>   | 4mm Clear Tempered Glass                  |
| <b>Frame Finish</b>   | Anodised / Power Coated                   |
| <b>Door Opening</b>   | Folding Type                              |
| <b>Extra Features</b> | Top/Down Closure Stripe, Premium S Handle |



## RB SERIES

Brass Chromed / 304 Stainless Steel

RB is a breakthrough in Shower Screen Industry by folding the panel of glass 360 degree. RB is innovated to minimize the door opening wastage of space the smallest the possible.

With RB Series Invention, small space is not a problem anymore.



**RB-180Z**  
2-Panel Folding

RB Series



### TECHNICAL DRAWING



### ACCESSORIES/ PARTS



180 Glass Hinge



SUS 304 S/S Steel Hinge System



Magnetic Strip



1108 S Steel Handle

**MODEL: RB-180Z**  
Glass Folding Shower

|                       |                                       |
|-----------------------|---------------------------------------|
| <b>Specification</b>  | 2-Panel Folding Glass Door            |
| <b>Infill Panel</b>   | 8mm Thick Clear Tempered Glass        |
| <b>Door Opening</b>   | Folding                               |
| <b>Extra Features</b> | Full SUS304 S. Steel Top Bar & Handle |



**RB-090R**  
2-Panel 180° Swing Door



TECHNICAL DRAWING

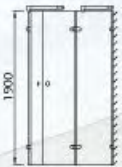
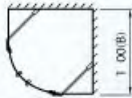

**RB-090**  
2-Panel 180° Swing Door



TECHNICAL DRAWING



**MODEL: RB-090Z**  
Glass Swing Shower



ACCESSORIES/ PARTS



H80 Glass Hinge



Sss 304 Header System



Aluminium U-Channel

|                       |                                       |
|-----------------------|---------------------------------------|
| <b>Specification</b>  | Corner Curve Shower                   |
| <b>Infill Panel</b>   | 8mm Thick Clear Tempered Glass        |
| <b>Door Opening</b>   | 180° Swing Door                       |
| <b>Extra Features</b> | Full SUS304 S. Steel Top Bar & Handle |

**MODEL: RB-090**  
Glass Swing Shower



ACCESSORIES/ PARTS



H80 Glass Hinge



Sss 304 Steel Header System



Aluminium U-Channel

|                       |                                       |
|-----------------------|---------------------------------------|
| <b>Specification</b>  | 2 Panel Swing                         |
| <b>Infill Panel</b>   | 8mm Thick Clear Tempered Glass        |
| <b>Door Opening</b>   | 180° Swing Door                       |
| <b>Extra Features</b> | Full SUS304 S. Steel Top Bar & Handle |

**RB-180**  
180° Swing Door



**TECHNICAL DRAWING**



**CORNER ENTRY**  
Top View, Steel Hanger



**WALL TO WALL**  
Top View, Steel Hanger

**MODEL: RB-180**  
Glass Swing Shower



**ACCESSORIES/ PARTS**



180°  
Wall Hinge



Sup. 304 Steel  
Hanger System



1.18" S. Steel  
Handle

|                       |                                     |
|-----------------------|-------------------------------------|
| <b>Specification</b>  | Wall To Wall                        |
| <b>Infill Panel</b>   | 8mm Thick Clear Tempered Glass      |
| <b>Door Opening</b>   | 180° Swing Door                     |
| <b>Extra Features</b> | Fully 304 S. Steel Top Bar & Handle |





## REH SERIES

Brass Chrome / 304 Stainless Steel

REH series available in four different shapes: Straight Wall, Diamond Shape and L Shape. REH is the most commonly seen for swing type shower. It comes complete with a full 304 stainless steel top header system, functional Stainless Steel Towel L-Handle, with its simplicity, it has become part of shower screen's legend.



**REH-100**  
180° Swing Door

REH Series

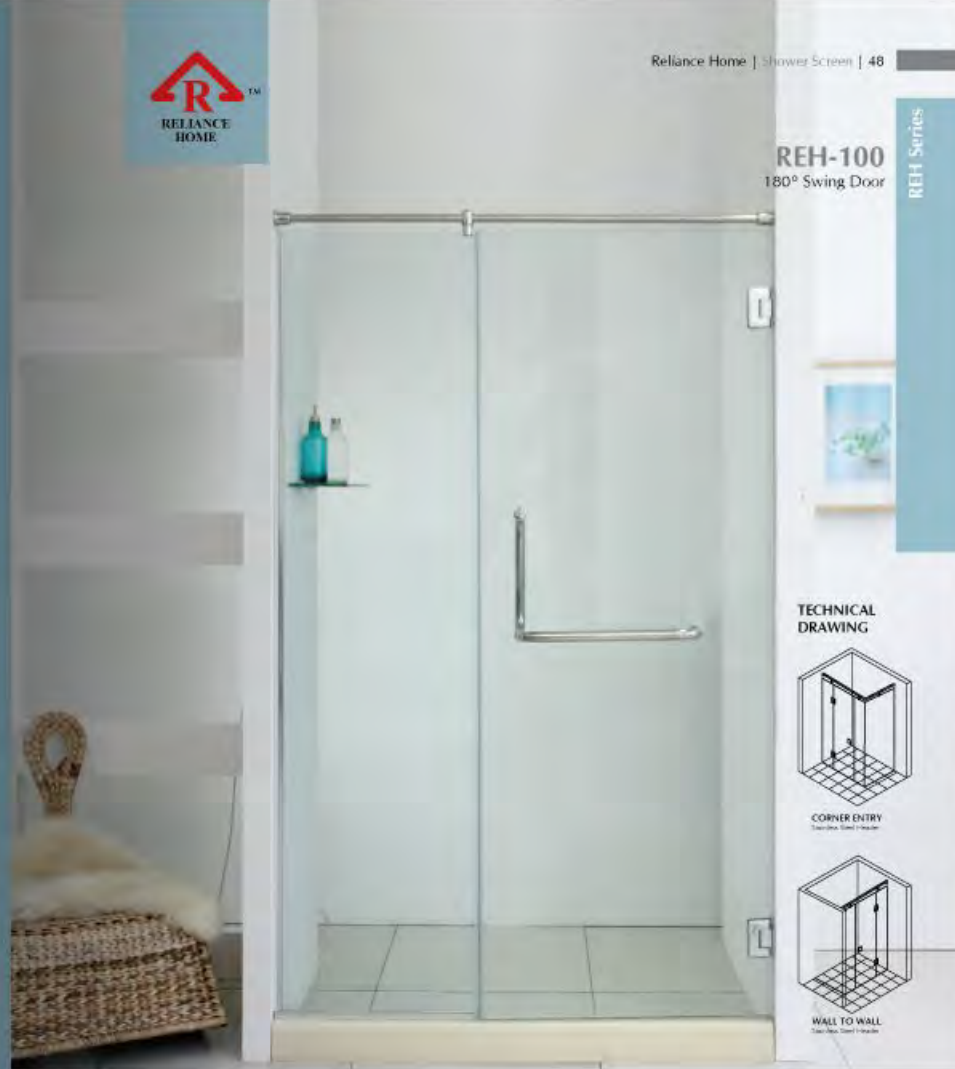

TECHNICAL  
DRAWING



CORNER ENTRY  
Stainless Steel Header



WALL TO WALL  
Stainless Steel Header

**MODEL: REH-100**  
Glass Swing Shower



ACCESSORIES / PARTS



REH-100



304 S Steel  
Header System



L100 S Steel  
L-Handle

|                       |                                       |
|-----------------------|---------------------------------------|
| <b>Specification</b>  | Stand-Alone Shower Screen             |
| <b>Infill Panel</b>   | 10mm Thick Clear Tempered Glass       |
| <b>Door Opening</b>   | 180° Swing Door                       |
| <b>Extra Features</b> | Full SUS304 S. Steel Top Bar & Handle |



**REH-200**  
Swing Door



TECHNICAL DRAWING



**REH-300**  
Swing Door



TECHNICAL DRAWING



CORNER ENTRY  
180° Swing Door



WALL TO WALL  
180° Swing Door

**MODEL: REH-200**  
Glass Swing Shower

ACCESSORIES / PARTS



REH-200



S104 S/Steel Header System



L106 S/Steel L-Handle



Waterproofing

|                       |                                       |
|-----------------------|---------------------------------------|
| <b>Specification</b>  | 135° Diamond Shape Shower             |
| <b>Infill Panel</b>   | 8mm Thick Clear Tempered Glass        |
| <b>Door Opening</b>   | Swing Door                            |
| <b>Extra Features</b> | Full SUS304 S. Steel Top Bar & Handle |

ACCESSORIES/ PARTS



REH-300



S104 S/Steel Header System



L106 S/Steel L-Handle



Waterproofing

**MODEL: REH-300**  
Glass Shower

|                       |                                 |
|-----------------------|---------------------------------|
| <b>Specification</b>  | 180° Straight Wall              |
| <b>Infill Panel</b>   | 10mm Thick Clear Tempered Glass |
| <b>Door Opening</b>   | Swing Door                      |
| <b>Extra Features</b> |                                 |

**REH-400**  
Swing Door



TECHNICAL  
DRAWING

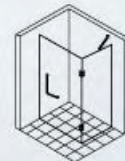

CORNER ENTRY  
Swing Door Header



"Shower Doors. Inspired by the Realities of Life".

**MODEL: REH-400**  
Glass Swing Shower



Water proof

ACCESSORIES / PARTS



REH-400



Sus 304 S. Steel  
Header System



L108 P. Steel  
L-Handle

|                       |                                       |
|-----------------------|---------------------------------------|
| <b>Specification</b>  | Corner Entry                          |
| <b>Infill Panel</b>   | 10mm Thick Clear Tempered Glass       |
| <b>Door Opening</b>   | Swing Door                            |
| <b>Extra Features</b> | Full SUS304 S. Steel Top Bar & Handle |



## 5018 SERIES

### Semi-Frameless

5018 series available in two different shapes: Wall to Wall and L-Shape. It comes complete with a full Aluminium top railing system, making these stunning shower panels truly elegant.



## 5018PL

### 2-panel Sliding Door

5018 Series



#### TECHNICAL DRAWING

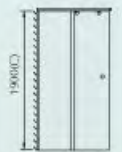

#### MODEL: 5018PL

Glass Sliding Shower

#### ACCESSORIES / PARTS



DH121-14



DH121-09



DH121-5

|                       |                                |
|-----------------------|--------------------------------|
| <b>Specification</b>  | L-Shape Sliding Shower         |
| <b>Infill Panel</b>   | 8mm Thick Clear Tempered Glass |
| <b>Door Opening</b>   | 2 Sliding Panel                |
| <b>Extra Features</b> | Aluminium Railing System       |



**5018P**

2-Panel Sliding Door



TECHNICAL DRAWING



**5018W**

2-panel Sliding Door



TECHNICAL DRAWING



**MODEL: 5018P**  
Glass Sliding Shower

ACCESSORIES / PARTS



|                       |  |
|-----------------------|--|
| <b>Specification</b>  | Wall To Wall Sliding Frameless         |
| <b>Infill Panel</b>   | 8mm Thick Clear Tempered Glass         |
| <b>Door Opening</b>   | 1 Fix Panel + 1 Sliding Panel          |
| <b>Extra Features</b> | Aluminium Top Track & Brass CHR Roller |

**MODEL: 5018W**  
Glass Sliding Shower

ACCESSORIES / PARTS



|                       |  |
|-----------------------|--|
| <b>Specification</b>  | Wall To Wall Sliding Frameless         |
| <b>Infill Panel</b>   | 8mm Thick Clear Tempered Glass         |
| <b>Door Opening</b>   | 1 Fix Panel + 1 Sliding Panel          |
| <b>Extra Features</b> | Aluminium Top Track & Brass CHR Roller |



'Let's shower at home, i miss the screen'.



5028P  
2-panel Sliding Door



MODEL: 5028P  
Glass Sliding Shower

ACCESSORIES / PARTS



DF-1121-54  
FI-96-168L  
Floor



DF-1121-09  
Roller



W-15-P  
Roller

|                       |                                     |
|-----------------------|-------------------------------------|
| <b>Specification</b>  | 2-Way Sliding Frameless Door        |
| <b>Infill Panel</b>   | 8mm Thick Clear Tempered Glass      |
| <b>Door Opening</b>   | 2 Way Sliding                       |
| <b>Extra Features</b> | Aluminium Top Track with Bar Handle |



## KK SERIES

### Full Stainless Steel Shower Series

KK series available in three different shapes: half round, straight L-Corner and Wall to Wall. It comes complete with a full 304 stainless steel top railing system, making these stunning shower panels truly elegant.



## KW-P51 Curved Panel Swing Door

KK Series



TECHNICAL  
DRAWING

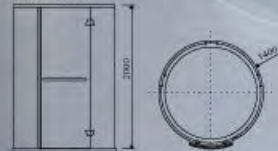

## MODEL: KW-P51 Glass Swing Shower

### ACCESSORIES / PARTS



|                       |                                       |
|-----------------------|---------------------------------------|
| <b>Specification</b>  | Stand-Alone Shower Screen             |
| <b>Infill Panel</b>   | 8mm Thick Clear Tempered Glass        |
| <b>Door Opening</b>   | Curved Panel Swing                    |
| <b>Extra Features</b> | Full SUS304 S. Steel Top Bar & Handle |



**KK-T41**  
2 Curved Panel Sliding



TECHNICAL DRAWING

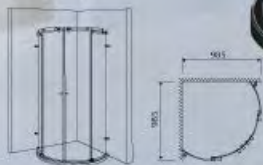

**MODEL: KK-T41**  
Glass Sliding Shower

ACCESSORIES / PARTS



|                       |                                       |
|-----------------------|---------------------------------------|
| <b>Specification</b>  | Corner Round Shape Shower             |
| <b>Infill Panel</b>   | 8mm Thick Clear Tempered Glass        |
| <b>Door Opening</b>   | 2 Curved Panel Sliding                |
| <b>Extra Features</b> | Full SUS304 S. Steel Top Bar & Handle |



**KK-T11**

**5018PL**  
2-panel Sliding Door



TECHNICAL DRAWING



**MODEL: KK-T11**  
Glass Sliding Shower

ACCESSORIES / PARTS



|                       |                                       |
|-----------------------|---------------------------------------|
| <b>Specification</b>  | Corner Entry Shower                   |
| <b>Infill Panel</b>   | 8mm Thick Clear Tempered Glass        |
| <b>Door Opening</b>   | 2-Panel Sliding                       |
| <b>Extra Features</b> | Full SUS304 S. Steel Top Bar & Handle |

KK Series

**KK-T72**  
2-Panel Sliding Door



TECHNICAL  
DRAWING

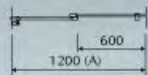

**MODEL: KK-T72**  
Glass Sliding Shower

ACCESSORIES / PARTS



|                       |                                       |
|-----------------------|---------------------------------------|
| <b>Specification</b>  | Wall to Wall Sliding Panel            |
| <b>Infill Panel</b>   | 8mm Thick Clear Tempered Glass        |
| <b>Door Opening</b>   | 1 Fix Panel + 1 Sliding Panel         |
| <b>Extra Features</b> | Full SUS304 S. Steel Top Bar & Handle |

these are the essences  
that tight us strongly

Quality Control



Intensive Human  
Resource Training



Customer Satisfaction



ACCESSORIES

### Shower Chair



ACCESSORIES

ACCESSORIES

### Shower Handle



DL-A13



DL-A32



DL-A00



L-210



L-108



DL-A00

### Glass Door Lock



TL-109



TL-110







KITCHEN CABINET



innovative  
*melamine.*



## BASICS

### 16MM MELAMINE

The Decorative Melamine Faced Board (MFB) is designed with Plain Board laminated on impregnated melamine paper. It comes in both moisture resistant (MUF V313 grade) and non-moisture resistant (UF grade) specifications



Premium supplier *behind the scene*



Kitchen Appliances  
Du Pont - USA



Electronic  
Teka/Electrolux



Solid Surface  
Du Pont - USA



Kitchen Fitting & Appliances  
Blum - Germany



## EXTRAVAGANT VENEER COLLECTION

"In Reliance Kitchen, we offer real and constituted wood veneer. When wood veneer is applied properly, it gives a piece the illusion that is made entirely from the same type of wood as the veneer."



Premium supplier *behind the scene*



Kitchen Fitting & Appliances  
Blum - Germany



Multifunctional Drawer



High Drawer



Soft-Close Door Hinge





## SPRAYPAINT 18MM MDF

Reliance Kitchen provides quality spraypaint MDF to give blast out your kitchen. This spraypaint board are highly durable and with its glossy surface, it definitely lighten out your cooking mood!

### Color Choices-

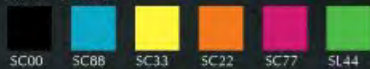

SC00 SC88 SC33 SC22 SC77 SL44



SC11 SC55 SL99 SL66 SL77



## Spraypaint aluminium Specification



16/18mm Aluminium Wood Edging and Built In Handle



18mm Aluminium Wood Edging  
Code: RK9018



18mm Wood Panel Built In Handle  
Code: RK9818



Code: LS451-100/150  
100mm Aluminium Skirting  
150mm Aluminium Skirting



16mm Aluminium Wood Edging  
Code: RK9016



16mm Wood Panel Built In Handle  
Code: RK9816





## CLASSICS SOLID WOOD

Our solid wood ranges from solid nyatoh, semangkok, oak, pine and many more to give a harmonious aesthetic touch to the kitchen.

The essence  
to plan a  
good kitchen design



*leading innovative lifestyle*

## Door Choice Antijump



AJ101



AJ102



AJ103



AJ104



AJ133



AJ143



AJ163



AJ173



AJ113



AJ114



AJ115



AJ122



AJ213



AJ112



AJ183



AJ123



## Antijump System aluminium Specification



5mm Side Handle Section  
Code: RK8050

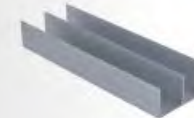

Double Top Rail  
Code: RK8180



Double Bottom Rail  
Code: RK8450



Door Bottom Section  
Code: RK8350



Panel Divider Section  
Code: RK8890



Mould Hair  
Code: RK8338



Aluminium Cloth Hanger  
Code: RK8229



Heavy Duty Roller Set



### THE WALK IN



### THE WALK IN



MELAMINE | The Walk In Series





## Decorative Glass

These resins are used to outline the areas to be coloured, are available in different colours and finishes and make any design more attractive. The most commonly used colours are black, which adapts well to glass and designs due to its versatility, silver and gold which, as they have a more liquid texture, provide finer lines and therefore smooth out the outlining effect of the design. The transparent outlining bead has a similar finish to stroked designs but with the advantage of being able to colour the inside of the design, which looks really quite wonderful on frosted glass.

### Glass Line Color Choice



Black



Crystal Clear



Gold

The Colours from our product will not fade and change colour. All raw materials come from UK. The quality of the decorative glass is exceeding normal standards that we provide a 10 Year Limited Warranty on the glass design. The Main Features are listed as of Below:

- Non Fading Colour
- Heat Resistance
- Water Resistance
- Weather Resistance for countries with 4 seasons
- Artbeaces are simply unique

### Artwork Sample:-



Imax 001



Imax 002



Imax 003



Imax K 001



Imax W 001



Imax W 002



## Decorative Glass

Now everyone can enjoy the fine art



### Kitchen Door



IMX KD009



IMX KD010



IMX KD011



IMX KD012



IMX KD013

### Wooden Door



IMX SD24



IMX SD25



IMX SD26



IMX SD27



IMX SD28



## Material Choice

### INFIL PANEL CHOICES

#### FRAME COLOR



8100 Silver



8400 Light Bronze



8200 Dark Brown



9033 Baby Blue



9018 White



7437m Grey



9054 Beige



9061 Pink



9067 Green



7006m Light Brown



7015m Black



4741 Dark Brown



9016 Cherry



9017 Acacia



9017 Tes. Acacia



9037 Accia



9052 Oak



9052 Tes. Oak



9053 Douglas



9103 Pine



9119 Walnut



9130 Walnut



9130 Tes. Walnut

### POLYSTYRENE SHEET



W27



C27



B27



LB27



W22



C22



B22



G22

W29



C29



B29



C20



B20



W30



LB30



LP30



CB30

C31

### ACRYLIC PANEL



RP 11



RP 22



RP 55



RP 77



RP 90



SP07  
Light Green



SP03  
Light Grey



SP05  
Light Brown

### LAMINATED GLASS



Ocean Blue



Emerald Green



Apple White



Dark Grey



Bronze Brown